

# HYDRO1 PEDESTRIAN FLOOD DOOR SYSTEM

## PASSIVE FLOOD PROTECTION BARRIER STEEL FLOOD DOOR, FRAME, AND HARDWARE

### VISION LITE OPTIONS:

(Viewable Opening Size Shown)

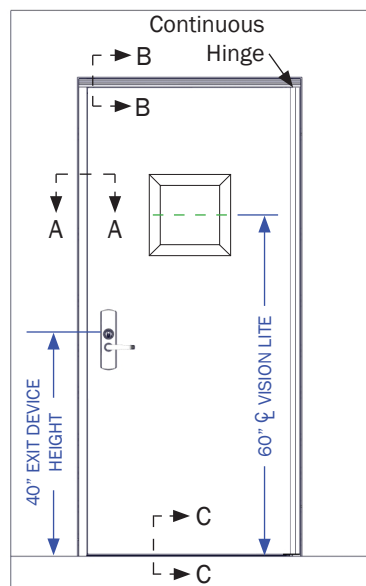
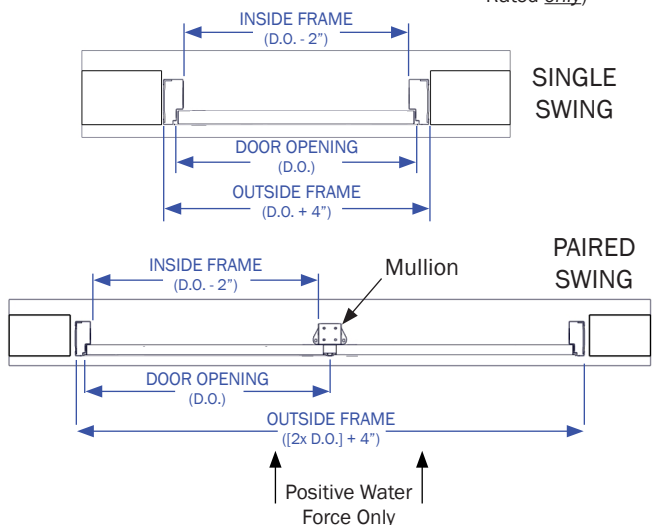
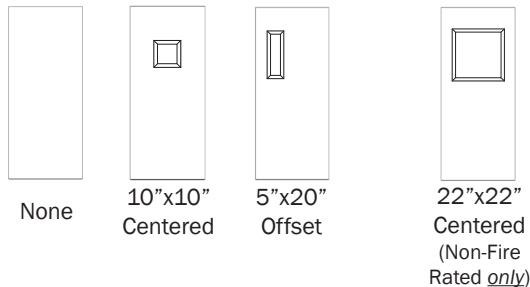

**Wet-Side Elevation**

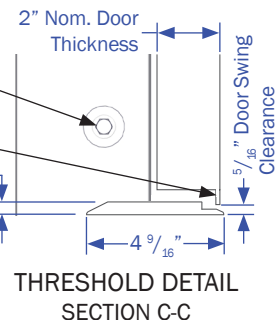
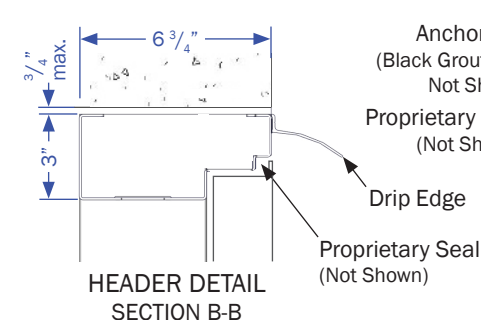
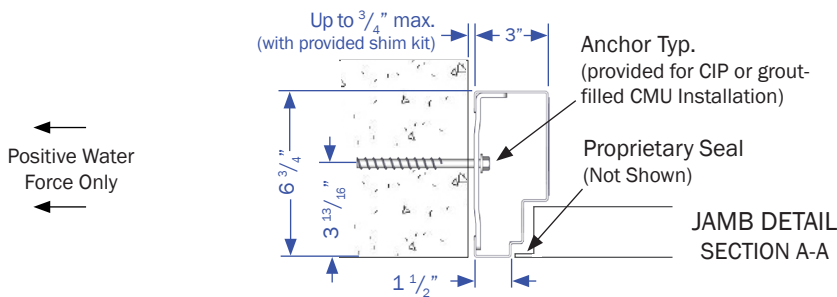

- Hydro1-PD520 Flood Door
- Hydro1-PD522 90 Min Fire Rated Flood Door
- Hydro1-PD525 Mechanical Room Flood Door

### HANDED:

(LHR, RHR, or PAIRED)

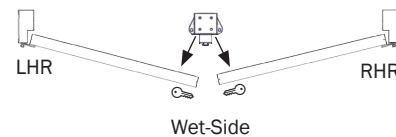

### SUGGESTED USE:

(INTERIOR or EXTERIOR)

Commercial, Health Care, Institutional, Retail, Factory, Warehouse, Government, Transit Authority, or Critical Infrastructure.

### HYDRO1-PD520/PD522 APPROVED/TESTED FLOOD DOOR

#### SYSTEM HARDWARE:

Von Duprin

- Interior: Von Duprin 98/99 series Rim exit device - (US28 Finish).
- Exterior: Von Duprin 996L Lever, classroom function - (US26D Finish).
- Closer: TownSteel TDC40 Cush - (AL689 finish).
- Continuous Aluminum Geared Hinge - (Clear Anodized Finish).
- Threshold: Gasket-Free, ADA Compliant - (Aluminum).
- Anchors, sealants, and waterstop provided.

### HYDRO1-PD525 APPROVED/TESTED FLOOD DOOR SYSTEM

#### HARDWARE:

- PS Flood Barriers' 2 Point Wedge Latch
- Continuous Aluminum Geared Hinge - (Clear Anodized Finish).
- Threshold: Gasket-Free, ADA Compliant - (Aluminum).
- Anchors, sealants, and waterstop provided.

These hardware sets have been specifically chosen, tested, and factory improved for flood resistance on the Hydro1, substitutions require manufacturer's engineering review. Hydro1-PD522 uses fire rated versions of Hydro1-PD520 hardware.

AVAILABLE MATERIAL TYPES				AVAILABLE MATERIAL FINISH				
DOOR CORE STRUCTURE <sup>1</sup>	TYPE	FRAME	DOOR SHEETS	PRIMER	INDUSTRIAL ENAMEL	No. 2b (Mill finish)	No. 4 (Brushed)	No. 6 (Polished)
Steel	Commercial Galvanealed	14 Gauge	16 Gauge	1 Coat	2 Coats	-	-	-
Stainless Steel	316	14 Gauge	16 Gauge	-	-	Standard	Optional	Optional

<sup>1</sup> Door panel core is structural tubing of appropriate size and strength with welded and bonded construction. All door panel edges are hemmed. Door panel insulation is R-8 batt fiberglass full depth of door panel cavity.

INDEPENDENT PARTY VALIDATED HYDROSTATIC PERFORMANCE TESTING <sup>1</sup>				
PEDESTRIAN FLOOD DOOR MODEL	TESTED WATER PROTECTION HEIGHT	TEST STANDARD <sup>2</sup>	MAX. ALLOWED LEAKAGE RATE <sup>3</sup> (gal/hr/lin. ft of wetted perimeter) <sup>5</sup>	MAX. TESTED LEAKAGE RATE <sup>4</sup> (gal/hr/lin. ft of wetted perimeter) <sup>5</sup>
Single HYDR01-PD520/PD522	3 ft	ANSI/FM 2510-2020	0.080	0.015 ✓
Single HYDR01-PD520/PD522	20 ft	ANSI/FM 2510-2020	0.080	0.004 ✓
Paired HYDR01-PD520/PD522	3 ft	ANSI/FM 2510-2020	0.080	0.022 ✓
Paired HYDR01-PD520/PD522	8 ft	ANSI/FM 2510-2020	0.080	0.025 ✓

<sup>1</sup> Testing conducted under factory test conditions. Field conditions and installation tolerances can differ. Always allow for some seepage and condensation from product and adjacent building structure.

<sup>2</sup> Testing conducted according to the latest ANSI/FM Approvals 2510-2020 4.3.3 procedure which requires leakage collection at both 10% and 100% max water protection height.

<sup>3</sup> The MAX. ALLOWED LEAKAGE RATE is 0.080 gal/hr/lin. ft during ANY 15-minute interval of the 22 hour test duration.

<sup>4</sup> The MAX. TESTED LEAKAGE RATE includes all leakage throughout the entire product assembly **including hardware and lock-set**. Certificates of Testing Performance available.

<sup>5</sup> gal/hr/lin. ft of wetted perimeter (Gallons per hour per linear foot of wetted perimeter).

#### PERFORMANCE PARAMETERS

- Passive Barrier or Flood Mitigation Product: A permanent barrier or other flood mitigation product that, after its initial installation, either requires no deployment or requires no human intervention for deployment.
- Gasket-free threshold and walking surface. Continuous flood seal located on panel perimeter.
- All water pressure loads and operating loads are transferred to the mounting surface.
- Flood barrier products are designed to be anchored into 8" grout-filled CMU, 3000 psi (min.) 8" CIP, or  $\frac{3}{8}$ " structural steel (Welded or Drill & Tap). Options available for non-standard wall substrates.
- Field grout jamps. Grout to be non-metallic, non-shrink type, capable of developing 3000 PSI compressive strength as placed. Grout material is provided by the Installer.
- Flood protection products are engineered to conform to the design requirements that are based on the latest adopted edition of the International Building Code (IBC), while including the application of the representative load combinations and appropriate equivalent load factor as recommended by the following, but not entirely limited to, applicable referenced standard documents and supplements. ASCE/SEI 7 & 24, FEMA (ref. IBC 2012), AISC, ADM, ACI, and ANSI/FM Approvals 2510-2020.
- Except as otherwise indicated, requirements for flood barriers, terminology, tolerances, standards for performance and workmanship are those specified as Type 2 Closures in Chapter 7, Section 701.1.2 of U.S. Army Corps of Engineers, EP 1165-2-314, 15 December 1995.
- These Type 2 Flood Closures/Barriers shall form essentially dry barriers or seals, allowing only slight seepage during the hydrostatic pressure conditions of flooding to the Regulatory Flood Datum (RFD) or the Design Flood Elevation (DFE). Seepage amounts will vary with conditions encountered. This issue should be addressed by the design professional and usage of sump or bilge type pumps should be used to offset potential water build-up.
- This product uses compressible seals, which are not dependent on inflation devices.
- Flood load acts in the direction that forces door panels closed.

FLOOD LOADING CAPACITY OF PRE-ENGINEERED PRODUCT DESIGN								
Door Panel Size	48" Water Protection Height		72" Water Protection Height		96" Water Protection Height		MAX WPH <sup>1</sup> if HSL <sup>2</sup> <i>only</i>	
	Masonry Wall Anchorage	Welded-in or Z-Frame support <sup>3</sup>	Masonry Wall Anchorage	Welded-in or Z-Frame support <sup>3</sup>	Masonry Wall Anchorage	Welded-in or Z-Frame support <sup>3</sup>	Masonry Wall Anchorage	Welded-in or Z-Frame support <sup>3</sup>
36" x 84"	505lbs impact	1850lbs impact	325lbs impact	1500lbs impact	150lbs impact	1300lbs impact	115" WPH	134" WPH
48" x 96"	375lbs impact	1100lbs impact	175lbs impact	875lbs impact	HSL <i>only</i>	625lbs impact	98" WPH	143" WPH

<sup>1</sup> WPH (Water Protection Height).

<sup>2</sup> HSL (Hydrostatic Loading).

<sup>3</sup> Optional: Z-Frame overlaps face of wall opening to provide structural support for non-standard wall construction.

- All debris impact forces are applied over a 12" x 12" area and include 8ft/s (79.6psf) hydrodynamic load.
- Localized bending may occur to sheeting, hardware, hinges, or other surfaces directly exposing to an impacting object but not affect barriers ability to withstand loads.
- All analysis was performed using applicable ASD and LRFD load factors in accordance with ASCE 7-10 chapter 2 for Non-Coastal flood zones.

**Custom Engineered Product Available** for specific loading requirements **from 0 to 20 ft water height**.